

ZACZEPY DLA CIĄGNIKÓW I MASZYN ROLNICZYCH

ZACZEPY KULOWE



ZK80S5D130

ZK80S4D110

ZK80S3D90

ROZSTAW OTWORÓW MOCUJĄCYCH	RODZAJ SWORZNIA	ŚREDNICA SWORZNIA, Ø	MAX NACISK PIONOWY S, [KG]	UCIĄG D, [KN]
140X80 Ø21	kulowy	80	5000	130
140X80 Ø21	kulowy	80	4000	110
140X80 Ø21	kulowy	80	3000	90

PASUJĄCE UCHA DYSZLA

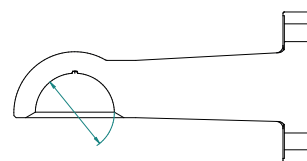
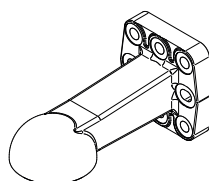

ZACZEPY PITON FIX



ZP50S4D110

ZP50S3D90

ROZSTAW OTWORÓW MOCUJĄCYCH	RODZAJ SWORZNIA	ŚREDNICA SWORZNIA, Ø	NACISK PIONOWY S, [KG]	UCIĄG D, [KN]
140X80 Ø21	piton fix	50	4000	110
140X80 Ø21	piton fix	50	3000	90

PASUJĄCE UCHA DYSZLA

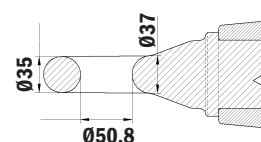
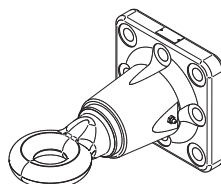

ZACZEPY AUTOMATYCZNE



AH38 HA4



AH31 HB4

ROZSTAW OTWORÓW MOCUJĄCYCH	RODZAJ SWORZNIA	ŚREDNICA SWORZNIA, Ø	NACISK PIONOWY S, [KG]	UCIĄG D, [KN]
140x80 Ø17/Ø21	baryłkowany	38	2500	100
140x80 Ø17/Ø21	prosty	38	2500	100

PASUJĄCE UCHA DYSZLA

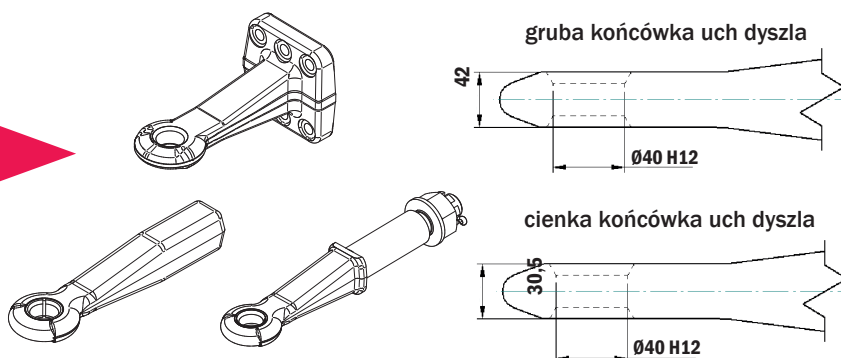

ZACZEPY MANUALNE



MH31 HE4



MH31 HE5

ROZSTAW OTWORÓW MOCUJĄCYCH	RODZAJ SWORZNIA	ŚREDNICA SWORZNIA, Ø	DO UCH DYSZLA	UCIĄG D, [KN]
140x80 Ø17/Ø21	prosty	32	40/50	100
160x100 Ø17/Ø21	prosty	32	40/50	100

PASUJĄCE UCHA DYSZLA

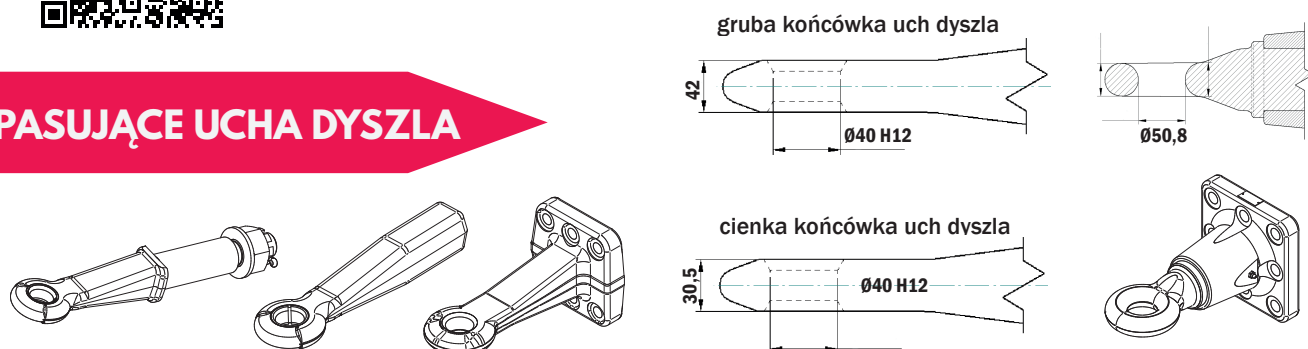

PŁYTY ADAPTACYJNE

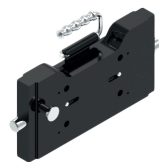
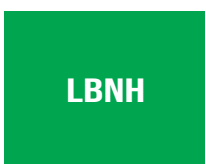

WYMIARY PŁYTY, [MM]	ROZSTAW OTWORÓW MOCUJĄCYCH	OTWORY GWINTOWE	NACISK PIONOWY S, [KG]	UCIĄG D, [KN]
312-31-22	140x80	M16/M20	4000	110
314-30-20		M20		
330-30-20		M20		
330-32-25		M16/M20		
335-30-22		M16/M20		
390-30-20		M20		
390-32-25		M16/M20		
333,5-37,5-25	140x80	M16/M20	4000	110
320-37,5-25				
310-37,5-25				
260-37,5-25				
330-30	140x80	M16/M20	4000	110

UCHA DYSZLA

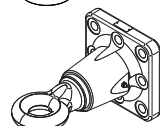
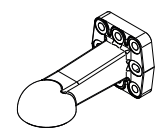
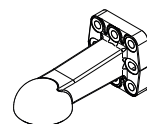
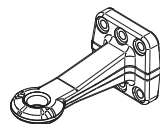
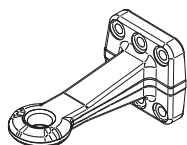
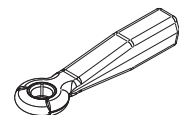

ROZSTAW OTWORÓW MOCUJĄCYCH	RODZAJ UCHA DYSZLA	DLA ŚREDNICY SWORZNIA	ŚREDNICA OTWORU, [MM]	UCIĄG D, [KN]
	wspawywany	30,5	40	125
145x145	na flanszy	30,5	40	105,7
110x100	na flanszy	30,5	40	125
110x100	na flanszy	80 do kuli	80 do kuli	125
145x145	na flanszy	80 do kuli	80 do kuli	125
145x145	na flanszy	50 do piton fix	50 do piton fix	102,4